

ERRATUM

Open Access

Erratum to: inferring the global structure of chromosomes from structural variations

Tomohiro Yasuda^{1,2} and Satoru Miyano^{1*}

Corrections

After publication of [1] we became aware that author revisions had not been incorporated into the final published version. The following corrections should be made. A PDF version into which all corrections are incorporated is attached as Additional file 1.

Formatting

Incorrectly formatted descriptions in [1] should be corrected as follows.

1. In the original publication, the images of Figures 1, 3, 5–9 are shuffled. In addition, images of Figures 1, 3, 4, 6–9 contain incorrectly encoded symbols. They should be replaced with Figures (1, 2, 3, 4, 5, 6, 7, 8, 9) presented in this article.
2. All four occurrences of “Yasuda and Miyano Page *n* of 11” in the main text should be removed.
3. All three occurrences of “ $O(|E|_2 \log |V| \log |E|)$ ” should read “ $O(|E|^2 \log |V| \log |E|)$ ”
4. In the Results, both of two “ $CC(\tilde{G}, E_+)$ ” should read “ $CC(\tilde{G}, E_+)$ ”
5. In the Methods, a Q.E.D. symbol “□(white box)” should be inserted at the end of the following lines:
 - The line just before Lemma 2
 - The line just before Lemma 3
 - The second line from below before “Proof of Theorem 2”, ending with “a Hamiltonian cycle on H .”
 - The line with the sentence “Therefore, C satisfies (6).” in subsection *Circular chromosome graph*
6. In the Background, “BCRABL” should read “BCR-ABL”

7. In the Methods, in the proof of *Lemma 1*, the expression “ $c = p_1 e_1 p_2 e_2 \dots e_i c p_i c_{i+1}$ ” should read “ $c = p_1 e_1 p_2 e_2 \dots e_i p_i c_{i+1}$ ”
8. In the same proof, just above *Lemma 2*, the expression “ $2|V|(n_N+n_T)+(4|V|+1)P_e * * *_{e \in E_S} n(e) \leq U(4|V|+1)(|E|+1)$ ” should read “ $2|V|(n_N + n_T) + (4|V| + 1) \sum_{e \in E_S} n(e) \leq U(4|V| + 1)(|E| + 1)$ ”
9. In the Methods, in the proof of *Lemma 3*, the following expressions

$$e_{i,1} = \langle -v_{i,1}^-, +v_{i,2}^+, 1, 1 \rangle \quad (2 \leq i \leq |V'|),$$

$$e_{i,2} = \langle -v_{i,2}^-, +v_{i,3}^+, 0, 1 \rangle \quad (2 \leq i \leq |V'|).$$

should read

$$e_{i,1} = \langle -v_{i,1}^-, +v_{i,2}^+, 1, 1 \rangle \quad (2 \leq i \leq |V'|),$$

$$e_{i,2} = \langle -v_{i,2}^-, +v_{i,3}^+, 0, 1 \rangle \quad (2 \leq i \leq |V'|).$$

10. In the Methods, in the proof of *Lemma 4*, in the paragraph that begins with “All of these steps”, the expression “ $m(C, e) = f(e) + f(\bar{e})(e \in E_S)$.” should read “ $m(C, e) = f(e) + f(\bar{e}) (e \in E_S)$.” (Insert a white space before “ $(e \in E_S)$ ”).
11. In the same proof, just before “Therefore, C satisfies (6).”, the expression “ $w(e, m(C, e)) = 0 (e \in E_L \cup E_R)$.” should read “ $w(e, m(C, e)) = 0 (e \in E_L \cup E_R)$.” (Insert a white space before “ $(e \in E_L \cup E_R)$ ”).

Inaccurate descriptions

The following items correct inaccurate descriptions in the original manuscript. We regret any inconvenience that they might have caused.

1. In the Results, in subsection *Formulation of the problem*, the phrase “its computational complexity was not analyzed” should read “its computational complexity was not intensively analyzed”

* Correspondence: miyano@hgc.jp

¹The Human Genome Center, Institute of Medical Science, University of Tokyo, Shirogane-dai, Minato-ku, Tokyo, Japan

Full list of author information is available at the end of the article

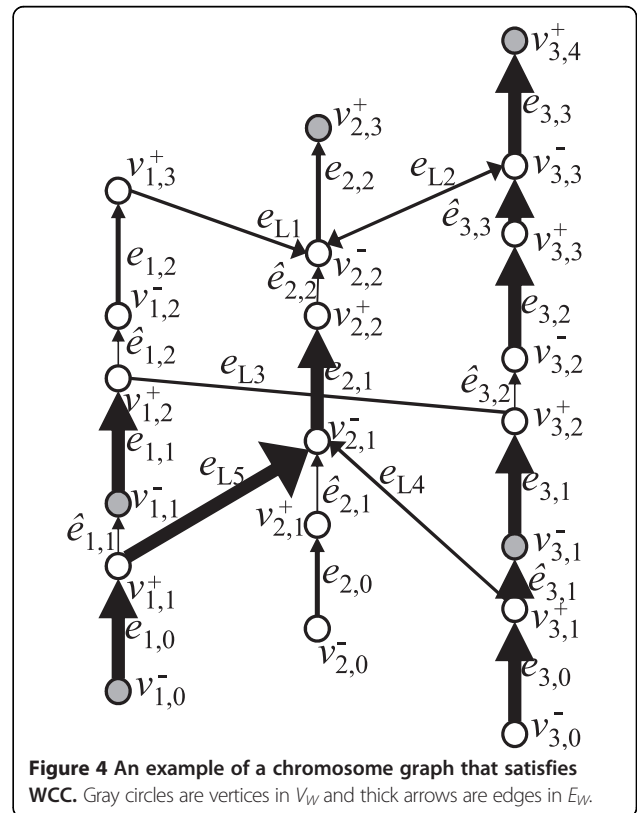
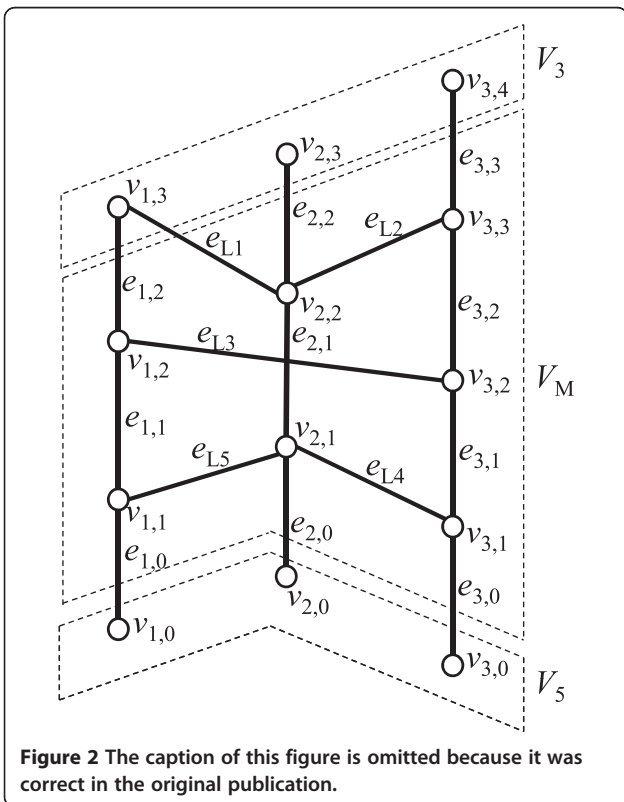
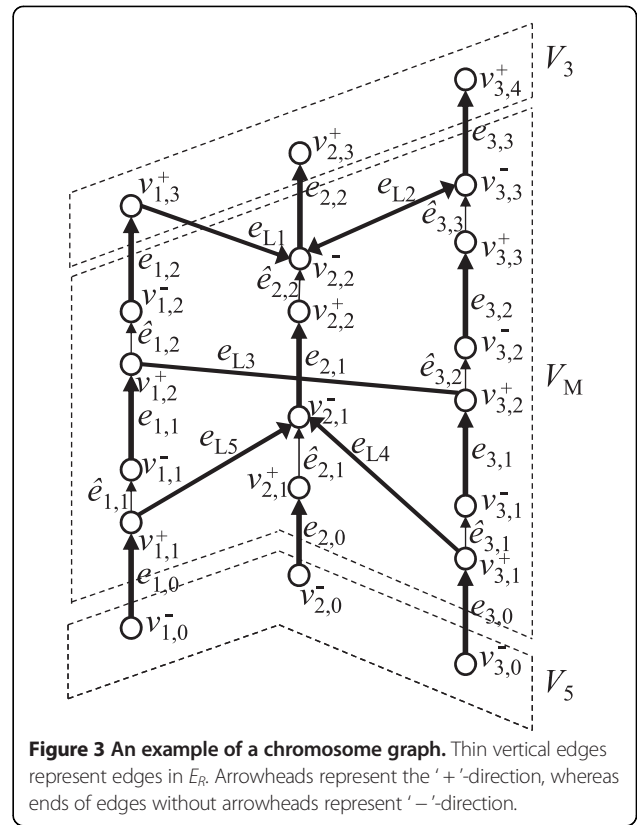
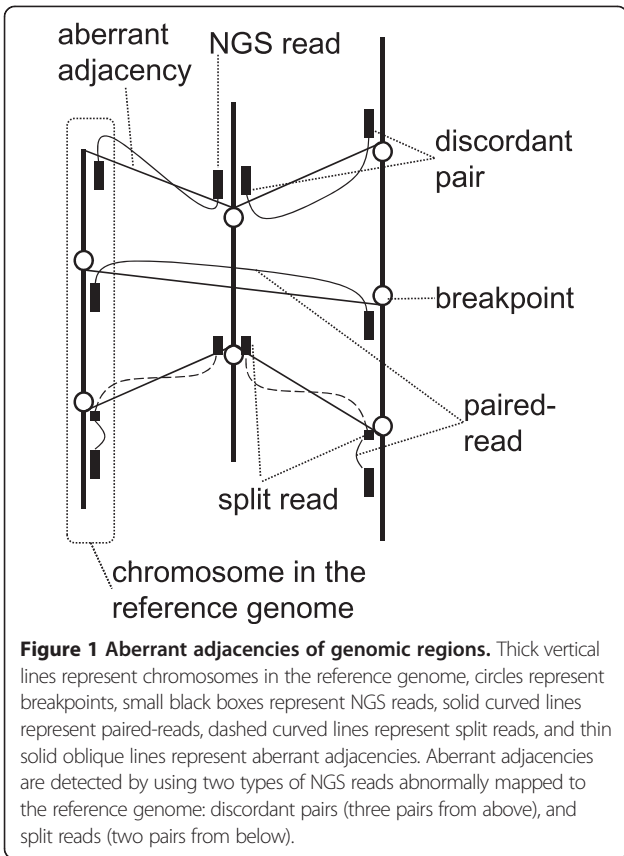

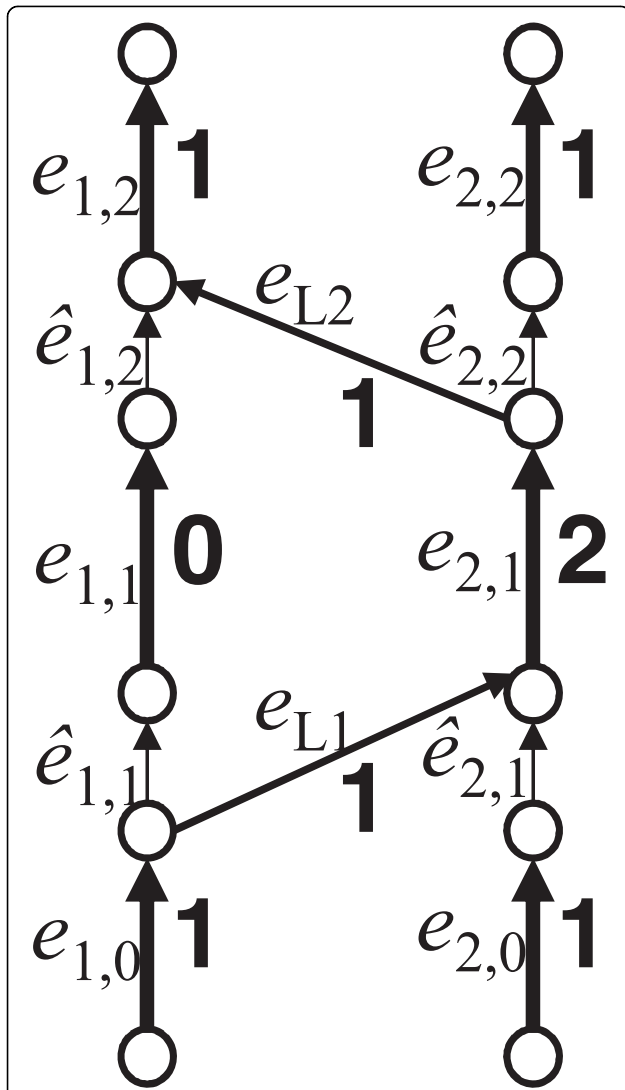

Figure 5 An example of a chromosome graph that has more than one optimal solution. Bold digits represent an optimal circulation on this graph. The chromosome graph in this figure has two optimal solutions $\{e_{1,0}e_{L1}e_{2,1}e_{L2}e_{1,2}, e_{2,0}\hat{e}_{2,1}e_{2,1}\hat{e}_{2,2}e_{2,2}\}$ and $\{e_{1,0}e_{L1}e_{2,1}\hat{e}_{2,2}e_{2,2}, e_{2,0}\hat{e}_{2,1}e_{2,1}e_{L2}e_{1,2}\}$. Edges in $E_N \cup E_D$ are omitted, and the flow on each edge in E_D has been subtracted from the flow of a corresponding edge in E_S .

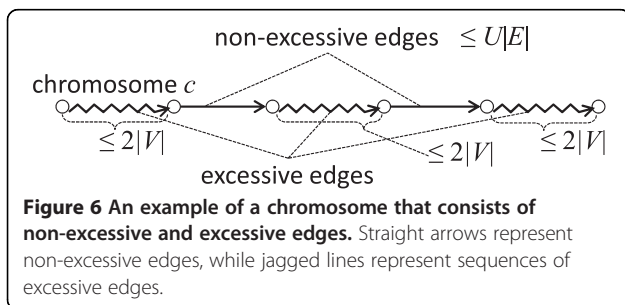

Figure 6 An example of a chromosome that consists of non-excessive and excessive edges. Straight arrows represent non-excessive edges, while jagged lines represent sequences of excessive edges.

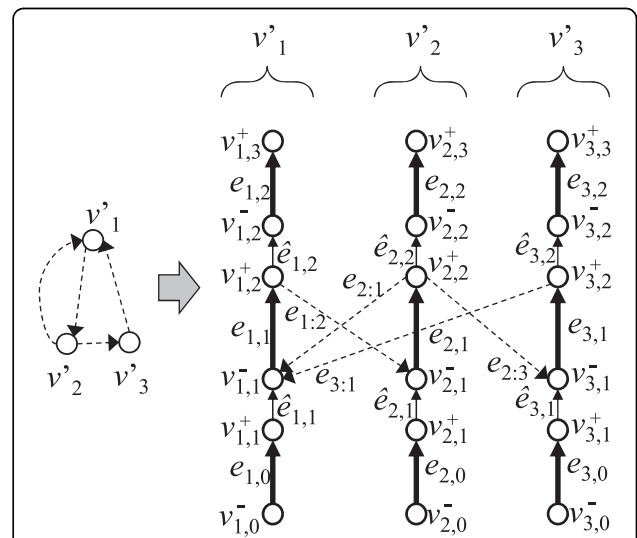

Figure 7 An instance of ChrP for solving the Hamiltonian Cycle problem (HC). In this graph, solid edges are constructed for each vertex in a graph H of HC, whereas dashed edges correspond to edges in H .

2. In the Results, in the first paragraph of subsection *Polynomial-time solvable variation*, both of two “ $E_L \cup E_R$ ” should read “ E ”
3. In the Results, in *Definition 2*, the phrase “if all $g \in CC(G, E_W)$ are good” should read “if all $g \in CC(G, E_W)$ are good and $n(e) = 0$ for $e \in E - E_W$ ”

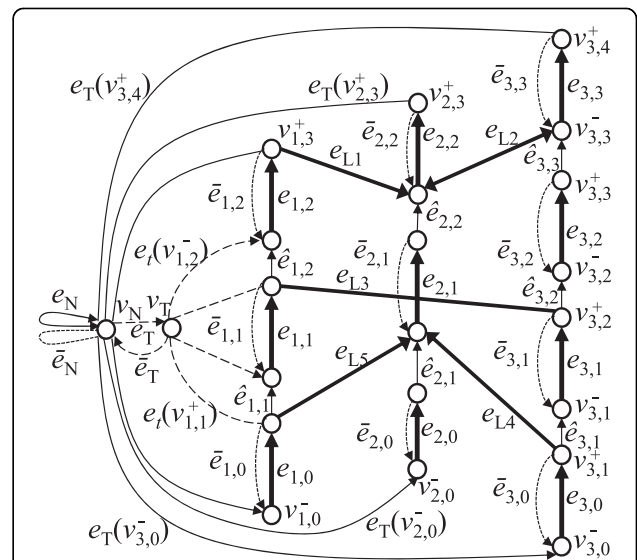
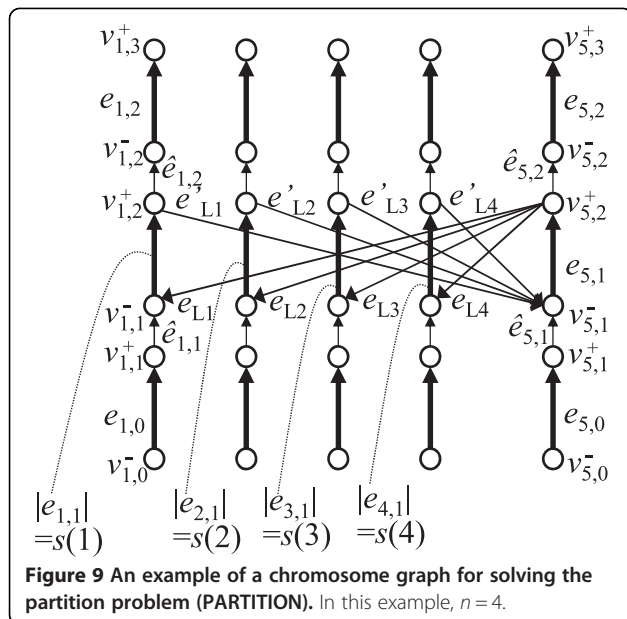

Figure 8 An example of a circular chromosome graph. The problem of optimizing multiple chromosomes is converted to the problem of finding a cycle on this graph. For simplicity, we omitted $e_T(\cdot)$, except for the leftmost chromosome in the reference genome.



4. In the Results, in the paragraph just after *Definition 2*, the expression “ $E_W = \{e \in E_S \mid n(e) \geq 1\} \cup \{e \in E_L \cup E_R \mid e \text{ is required}\}$ ” should read “ $E_W = \{e \in E \mid e \text{ is required}\}$ ”
5. In the Results, the last sentence that begins with “Finally, if some” just before *Definition 3* should read as follows:
 “In addition, if some $g \in CC(G, E_W)$ that are not good still remain, edges e in g are forcibly removed from E_W by changing e not required and setting $n(e)$ to 0. Finally, if $n(e) > 0$ for some $e \in E - E_W$, e is changed to be required and added to E_W by confirming its existence, or $n(e)$ is forcibly set to 0.”
6. In the Results, *Definition 3* should read “Let $G = (V, E)$ be a chromosome graph that satisfies WCC with respect to given $V_W \subset V$ and $E_W \subset E$. Then, find a set C of chromosomes on G that minimizes $W(C)$ when (3) is satisfied, each $v \in V_W$ is at an end of some $c \in C$, and each $e \in E_W$ appears in C .”
7. In the Methods, in the paragraph just above *Lemma 4*, the sentences “For $e \in E_S \cup \{e_N, e_T\}$, we set $l(e) = n(e)$, $l(\bar{e}) = 0$, and $u(\bar{e}) = n(e)$. For $e \in E_L \cup E_R$, we set $l(e) = 1$.” should read “For $e \in E_S \cup \{e_N, e_T\}$, we set $l(e) = n(e)$, $l(\bar{e}) = 0$, and $u(\bar{e}) = n(e)$ if e is not required, whereas $l(e) = \max\{n(e), 1\}$, $l(\bar{e}) = 0$, and $u(\bar{e}) = \max\{n(e) - 1, 0\}$ if e is required. We assume that e_N is required because $n_N \geq 1$. We also assume that e_T is required if $|V_W| \geq 1$. For $e \in E_L \cup E_R$, we set $l(e) = 1$ if e is required, or $l(e) = 0$ otherwise.”
8. In the Methods, in the paragraph just after *Lemma 4*, the description “or $n(e) \geq 1$ ” should be removed.

9. In the Methods, in subsection *Proof of Theorem 3*, the phrase “by making all edges in $E_L \cup E_R$ required” should read “by making all edges required”

Additional file

Additional file 1: Corrected version. A PDF version of [1] into which all corrections in this article are incorporated.

Author details

¹The Human Genome Center, Institute of Medical Science, University of Tokyo, Shirogane-dai, Minato-ku, Tokyo, Japan. ²Department of Computer Science, University of Tokyo, Hongo, Bunkyo-ku, Tokyo, Japan.

Received: 11 February 2015 Accepted: 11 February 2015
 Published: 9 April 2015

Reference

1. Yasuda T, Miyano S. Inferring the global structure of chromosomes from structural variations. *BMC Genomics*. 2015;16 Suppl 2:13.

Submit your next manuscript to BioMed Central and take full advantage of:

- Convenient online submission
- Thorough peer review
- No space constraints or color figure charges
- Immediate publication on acceptance
- Inclusion in PubMed, CAS, Scopus and Google Scholar
- Research which is freely available for redistribution

Submit your manuscript at www.biomedcentral.com/submit

